

# ActiveCount100

M I C R O B I O L O G I C A L   S A M P L E R



Operators Manual

This page intentionally left blank

Copyright © 2018 by Lighthouse Worldwide Solutions. All rights reserved. No part of this document may be reproduced by any means except as permitted in writing by Lighthouse Worldwide Solutions.

The information contained herein constitutes valuable trade secrets of Lighthouse Worldwide Solutions. You are not permitted to disclose or allow to be disclosed such information except as permitted in writing by Lighthouse Worldwide Solutions.

The information contained herein is subject to change without notice. Lighthouse Worldwide Solutions is not responsible for any damages arising out of your use of LMS applications and Lighthouse instruments.

ActiveCount™, ActiveCount100™, ActiveCount100H™ LMS™, LMS Express™, LMS Pharma™, and ApexRemote™ are trademarks of Lighthouse Worldwide Solutions.

Microsoft®, Microsoft Windows™, and Excel™ are trademarks of Microsoft Corporation.

Manufactured by:

Lighthouse Worldwide Solutions  
1221 Disk Drive  
Medford, Oregon 97501  
[www.golighthouse.com](http://www.golighthouse.com)

# Table of Contents

<b>EU CE DECLARATION OF CONFORMITY .....</b>	<b>5</b>
<b>Introduction.....</b>	<b>6</b>
ActiveCount100 Basics .....	6
Safety Warnings .....	6
Touch Screen Calibration.....	7
Quick look at ActiveCount100.....	8
Plug In USB Flash Drive and Charge Battery.....	9
Get Ready For Sampling .....	10
<b>Interpret Results.....</b>	<b>11</b>
Microorganism Sampling Principles .....	11
Constant and Periodic Sampling Modes.....	12
Continuous Sampling Exercise.....	14
Periodic Sampling Exercise.....	15
Security: Configuration Lock .....	16
Status LED Indicates Sampling Status .....	17
Sampling Status Screens .....	18
Sampling Run Metadata .....	18
<b>Total Sampling Volume.....</b>	<b>19</b>
Select Total Sampling Volume.....	19
Active Volume Applies to Sampling Runs.....	19
<b>Locations and Users.....</b>	<b>20</b>
Assigns Active Location to Sampling Runs .....	20
Assigns Active User to Sampling Runs.....	21
<b>Data Logging – Sampling Metadata.....</b>	<b>22</b>
Save Sampling Metadata to USB Flash Drive.....	22
<b>Status Indicators.....</b>	<b>23</b>
Device Status Indicators.....	23
<b>Settings.....</b>	<b>25</b>
ActiveCount100 Settings.....	25
<b>Tripod/Monopod.....</b>	<b>26</b>
Vertical and Horizontal Sampling.....	26
<b>Optional Compressed Gas Sampler.....</b>	<b>27</b>
Verify Nominal Flow Before Gas Sampling .....	27
<b>Clean and Disinfect.....</b>	<b>30</b>
Avoid Cross Contamination .....	30
External Enclosure .....	30
Sampling Head & Dust Cover.....	30
Transport .....	30
Warnings .....	31
<b>Calibration.....</b>	<b>32</b>
Calibration – Contact Authorized Facility.....	32
<b>Technical Specifications.....</b>	<b>33</b>
Benefits .....	33
Features .....	33
Package Contents .....	34
Conforming Specifications.....	34
Additional Help.....	34
<b>Appendix A: Database Files.....</b>	<b>35</b>

Databases in Comma-Delimited Files .....	35
Location Database .....	35
User Database.....	35
Sampling Run Databases.....	36
Appendix B: Feller Conversion Table .....	38
Sampling Head with 300 Holes x 0.6mm.....	38
Appendix C: Limited Warranty.....	39
Limitation of Warranties .....	39
Warranty of Repairs After Initial Two (2) Year Warranty.....	39



**Manufacturer's Name:** Lighthouse Worldwide Solutions, Inc.

**Manufacturer's Address:** Lighthouse Worldwide Solutions, Inc.  
1221 Disk Drive  
Medford, OR 97501 USA

**Declares the product:**

**Product Name:** ActiveCount  
**Model Number(s):** ActiveCount100

**Conforms to the following Product Specifications:**

<b><u>SAFETY</u></b>	EN61010-1:2010	Safety Requirements for Electrical Equipment for Measurement, Control, and Laboratory Use Part 1: General Requirements IEC 61010-1:2010
	CAN/CSA C22.2	Safety Requirements for Electrical Equipment for Measurement, Control and Laboratory Use, Part 1: General Requirements
	No. 1010.1-1992	
<b><u>EMC</u></b>	EN61326-1:2006	Electrical Equipment for Measurement, Control and Laboratory Use EN 61326-1:2006

UL 61010A-1 - UL Standard for Safety Electrical Equipment for Laboratory Use; Part 1: General Requirements  
Replaces UL 3101-1

**Supplementary information**

The product herewith complies with the requirements of the Low Voltage Directive 73/23/EEC amended by Directive 93/68/EEC and the EMC Directive 89/336/EEC amended by Directive 93/68/EEC and carries the CE marking accordingly.

A handwritten signature in black ink, appearing to read "Hanford Choy", is positioned above the printed name.

Fremont, CA. Oct 31, 2015

Hanford Choy – Director, Engineering

# Introduction

## ActiveCount100 Basics

---

Monitoring air for live microorganisms is essential when manufacturing hygiene-sensitive products in safe and sterile environments, such as:

- Pharmaceutical, hospital, food & beverage
- Cleanrooms, biological safety cabinets, isolators
- IAQ indoor air quality, museums, libraries
- Cosmetics, textiles, agricultural, environment
- Additional aseptic environment monitoring applications

Microorganisms have the potential to contaminate industrial products and harm human health.

ActiveCount100 is a high-performance instrument that uses a well-known method, *impaction*, to aspirate air through a perforated plate and deposit airborne bacteria onto an agar-coated petri dish. The petri dish is then removed, incubated, and tested for live microorganisms.

## Safety Warnings

---

### ActiveCount100 Safety Warnings

- If the ActiveCount100 is /was used in Biosafety Level 2 (BSL2) or higher, please contact your nearest Lighthouse Worldwide Solutions service center to follow the required decontamination procedures before returning the unit for service or calibration.
  - Service Contact: <https://www.golighthouse.com/en/technical-support-request>
- Do not sample flammable or corrosive gases.
- ActiveCount100 gas sampler is designed to sample compressed air, CO<sub>2</sub> or NO<sub>2</sub> only.
- To minimize the chance of electric shock, turn off the instrument and disconnect power adapter during sterilization.
- Do not charge ActiveCount100 with a power supply other than one provided by Lighthouse Worldwide Solutions.
- Do not submerge ActiveCount100 in any liquids.
- Do not spray disinfectant solution directly into ActiveCount100 enclosure.
- Do not use gasses to disinfect ActiveCount100.

## Touch Screen Calibration

The ActiveCount100H 3.5” color touch screen is calibrated prior to shipping and there should be no need to recalibrate at any time. Alternatively touch screen calibration may be performed at any time by following the steps outlined here.

### Touch Screen Calibration

1. Power off the ActiveCount100H.
2. While holding your finger on the touch screen; Power on ActiveCount100H and continue to hold your finger on the touch screen until the “Performing touch screen calibration” screen appears.
3. Follow the prompts to calibrate the touch screen by pressing and releasing on the filled circles for all four corners.





## Quick look at ActiveCount100

- User-friendly and easy to use
- Large 3.5" (8.9 cm) color touchscreen
- Airflow 100 liters per min ± 4%
- 8 programmable target volumes
- 50 programmable users
- 400 programmable locations
- Programmable delay start
- Continuous and periodic sampling modes
- Sampling head dust cover
- Autoclavable sampling head and dust cover
- Aluminum sampling head
- Stainless steel sampling head (optional)
- Uses standard ISO 24998 90mm petri dishes
- Status LED
- Allen wrench to adjust petri dish holder
- Lithium ion rechargeable battery
- Battery life 6 hours, typical sampling
- Battery charge time 4 hours
- Data logging to USB flash drive
- Store sampling metadata on USB flash drive
- Supports 3/8" tripod screws
- Tripod adapter for 1/4" tripod screws
- Calibration reminder
- Calibration certificate
- Carrying case
- Optional compressed gas sampler

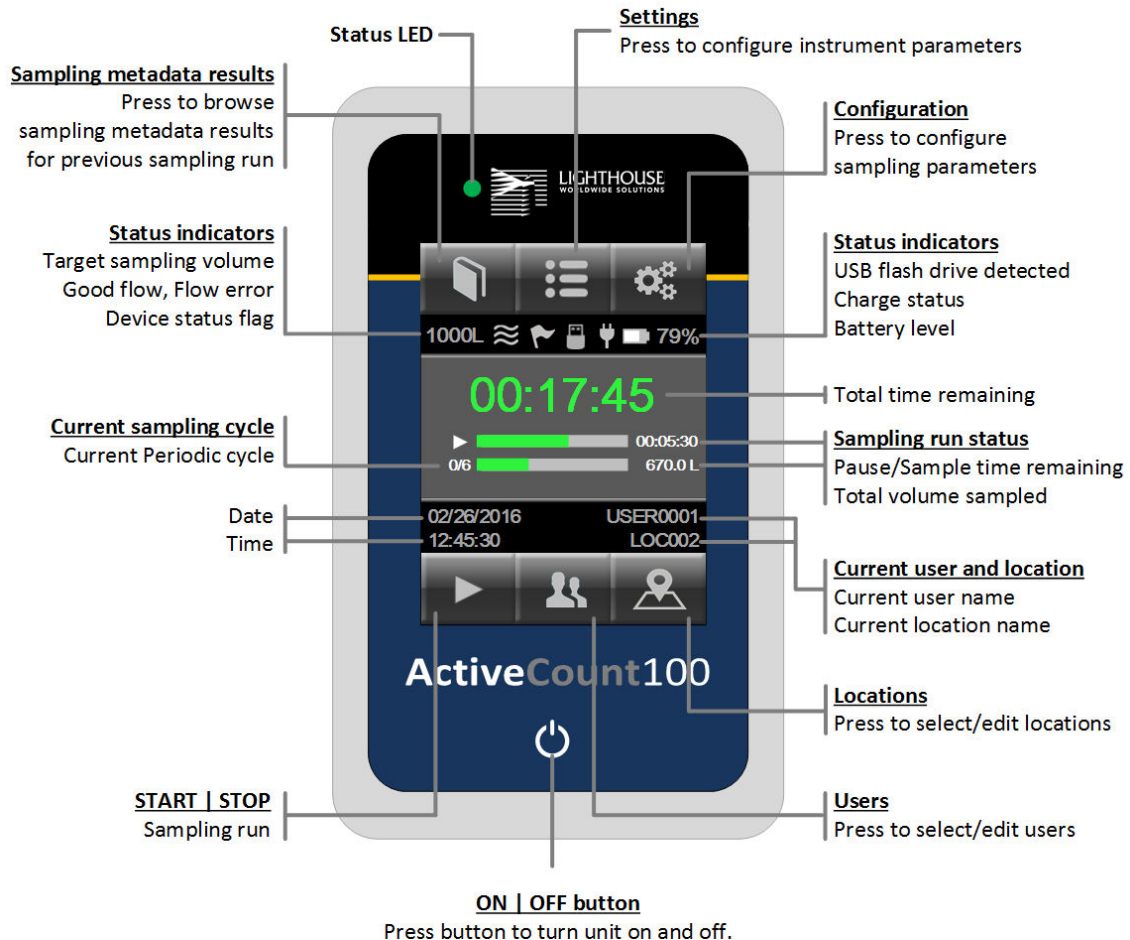

ActiveCount100 Home Screen

## Plug In USB Flash Drive and Charge Battery

---

**Data logging.** Insert the included USB flash drive to store sampling run metadata.

**Charge battery.** Follow the instructions below to charge the ActiveCount100 battery. To achieve a fully charged battery, please allow four hours.

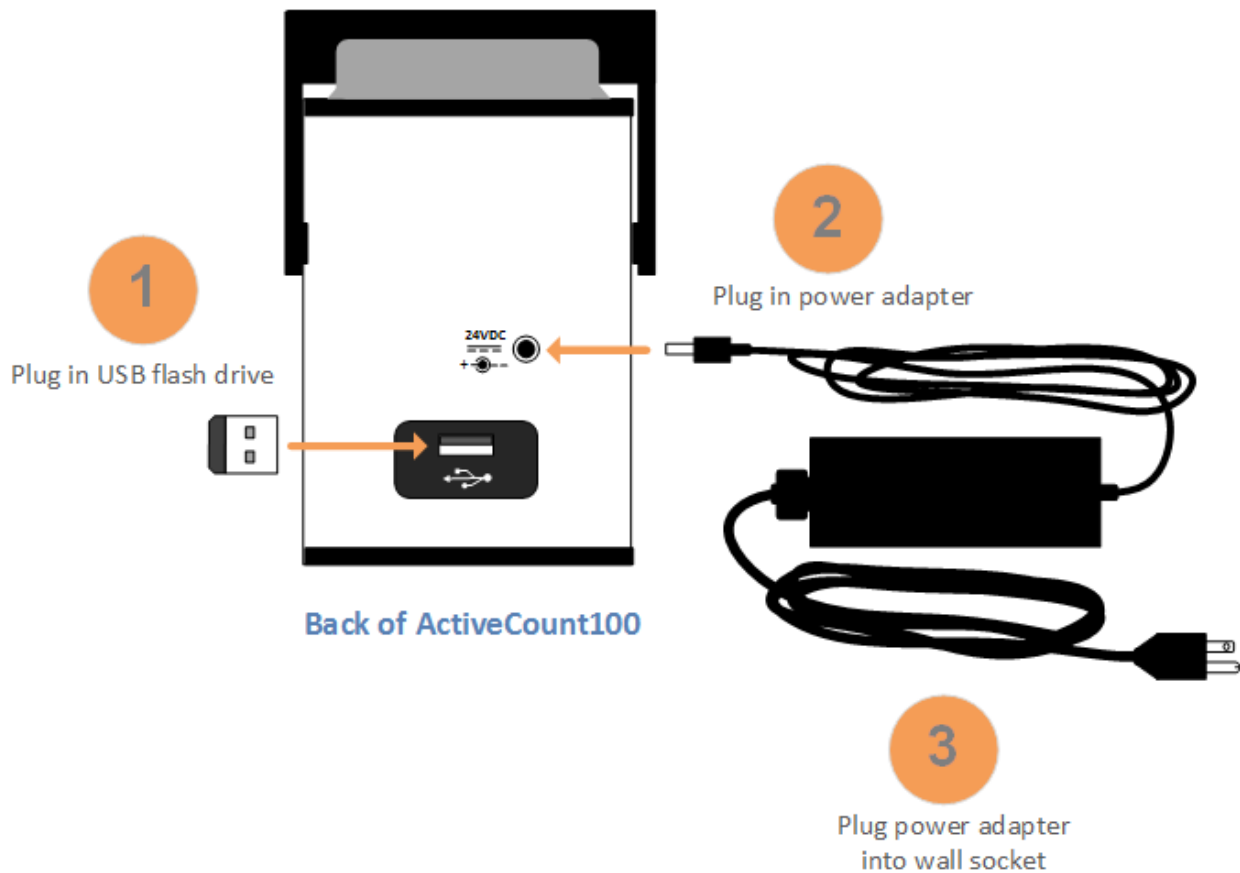

# Get Ready For Sampling

Follow these steps to prepare Activecount100 for microorganism sampling. When ActiveCount100 is not in use, always cover sampling head with dust cover.

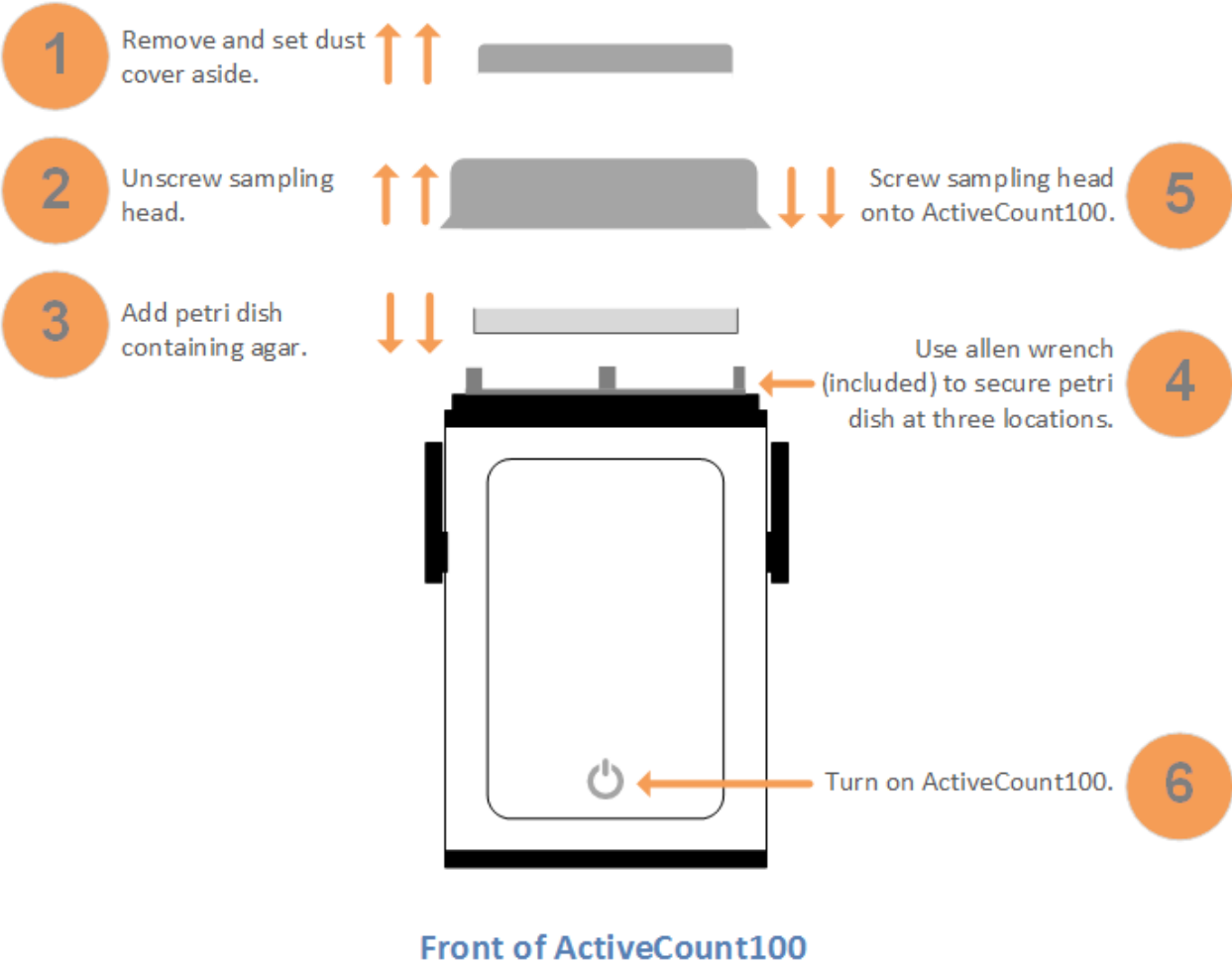

# Interpret Results

## Microorganism Sampling Principles

---

Microorganisms can be found in droplets suspended in air for long periods, and can contaminate hygiene-sensitive environments. These droplets fall and settle on surfaces, potentially causing infections in medical facilities and contamination in manufacturing facilities.

MPN (most probable number) is a well established method to estimate the number of viable microorganisms in a monitored area. To derive MPN, ActiveCount100 uses the principle that statistically assumes an increasing number of organisms enter the same hole in the sampling head as the number of organisms per sample rises.

After sampling, incubate the petri dish to determine the number of Colony Forming Units (CFU). Then, refer to the Feller Conversion Table in Appendix B to find the Most Probable Number (MPN) of microorganisms.

As an example, if an incubated agar sample contains 5 CFUs, the Feller Conversion Table shows the MPN is 5.

# Sampling Modes

## Constant and Periodic Sampling Modes

ActiveCount100 supports two sampling modes:

- Constant – samples *continuously* for a user-specified volume of air
- Periodic – samples *periodically* for a user-specified time and volume

Sampling Mode	Description
---------------	-------------

### Constant

ActiveCount100 continuously samples until it reaches the desired sample volume at 100 liters per minute  $\pm$  4%.

For the example below, select 1,000 liters of air as the desired volume. ActiveCount100 performs the following calculation to determine the sampling period is 10 minutes.

$$1,000 \text{ liters} \div 100 \text{ liters/minute} = 10 \text{ minutes}$$

#### Constant Mode Example

Sample 1000 liters in 10 minutes at  
100 liters per minute

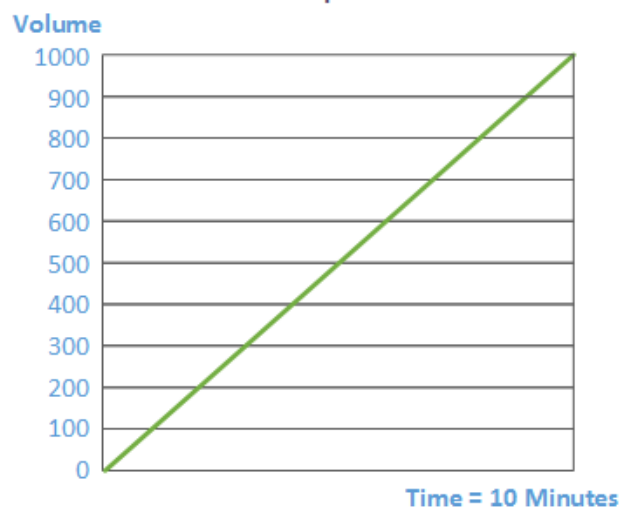

Sampling Mode	Description
---------------	-------------

**Periodic**

ActiveCount100 samples *periodically* for a user-specified number of cycles and for a user-specified period until it reaches the user-specified volume at 100 liters per minute.

Periodic mode is useful when monitoring a process over longer periods, e.g., manufacturing a batch or lot of food, cosmetics or drugs.

In the example below, select ten cycles over two hours and 1,000 liters of air. ActiveCount100 determines ten one-minute sampling cycles are needed over two hours.

$$1,000 \text{ liters} \div 100 \text{ liters/minute} = 10 \text{ minutes}$$

Pause between cycles. ActiveCount100 calculates the number of minutes to pause between ten one-minute samples over two hours, or 12.22 minutes.

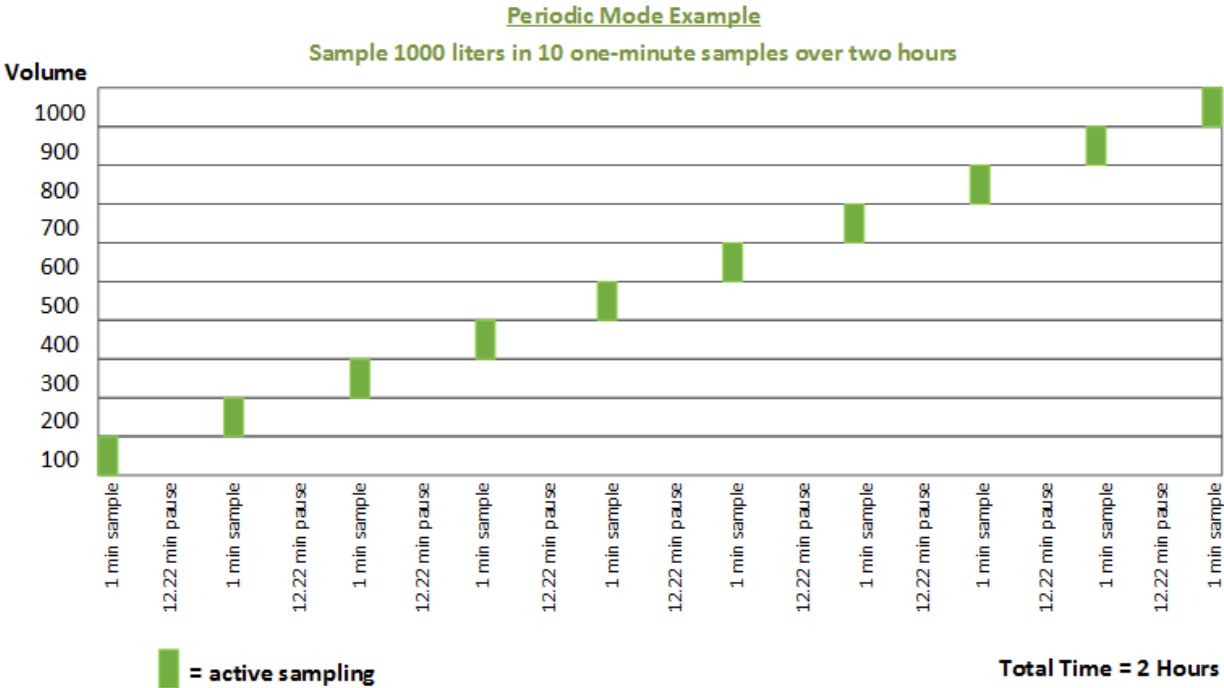

## Continuous Sampling Exercise

**Select Constant mode:** At the Home screen, press CONFIGURATION button. Select Constant in Mode menu item, then select total sampling volume. If desired, also select an optional delay time (in seconds). Press HOME button to return to the Home screen.

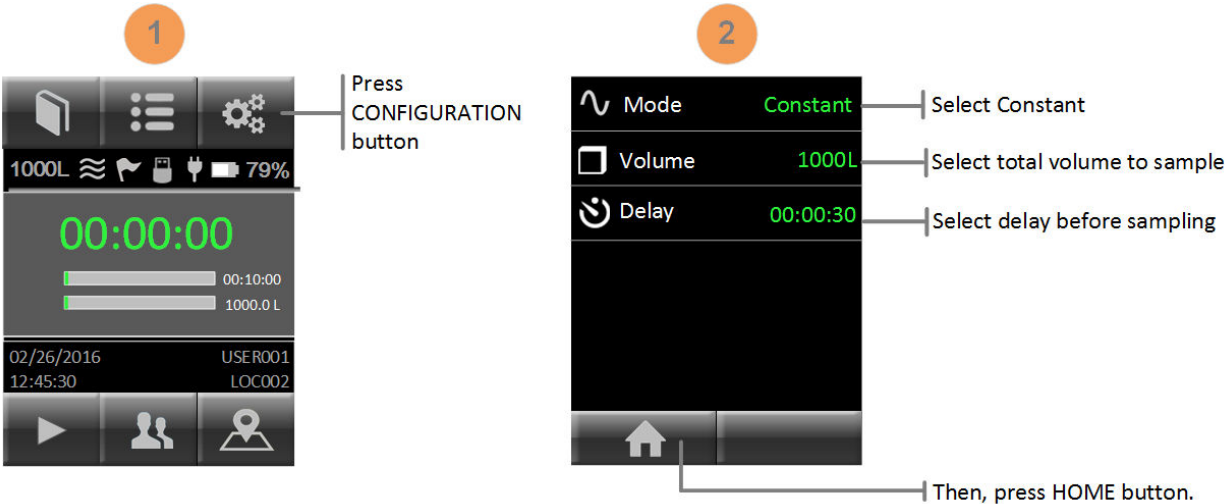

**Begin sampling:** Press START button to begin sampling.

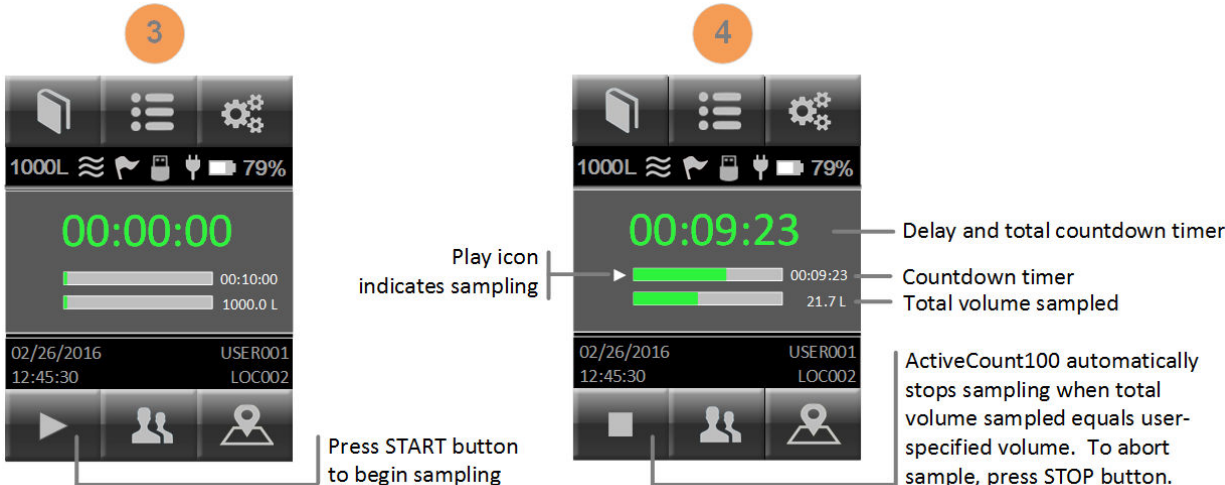

**Save sampling metadata:** To save metadata for each sampling run, insert the included USB flash drive into the rear USB port.

# Periodic Sampling Exercise

**Select Periodic mode:** At the Home screen, press CONFIGURATION button. Select Periodic in Mode menu item, then select total sampling volume, delay time, total time to sample and the number of cycles. Press HOME button to return to the Home screen.

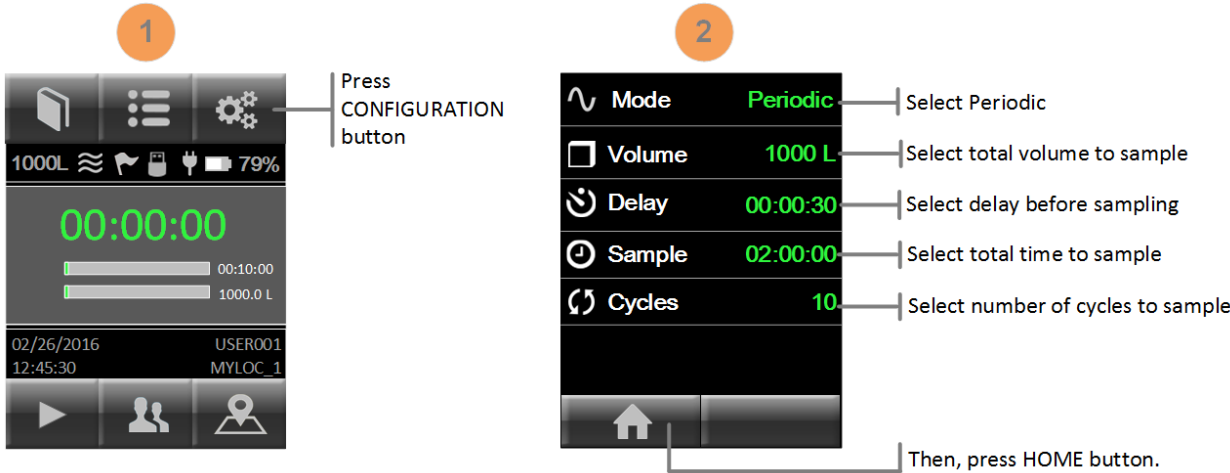

**Begin sampling:** Press START button to begin sampling.



**Store sampling metadata:** To store metadata for each sampling run, insert the included USB flash drive into the rear USB port.



# Security: Configuration Lock

ActiveCount100 Sampling Modes can be restricted by locking the Configuration Screen. Before locking the configuration screen; select the sample mode and sample settings to be locked.

**Configuration Lock:** With the configuration screen locked; users are restricted to the preselected sample mode (Constant/Periodic/Gas). The user may not select any other sample mode and may not change any sample parameters. The user may run the selected sample only.

- From the Home screen press Configuration and then press the LOCK icon button. This will bring up the Security screen.

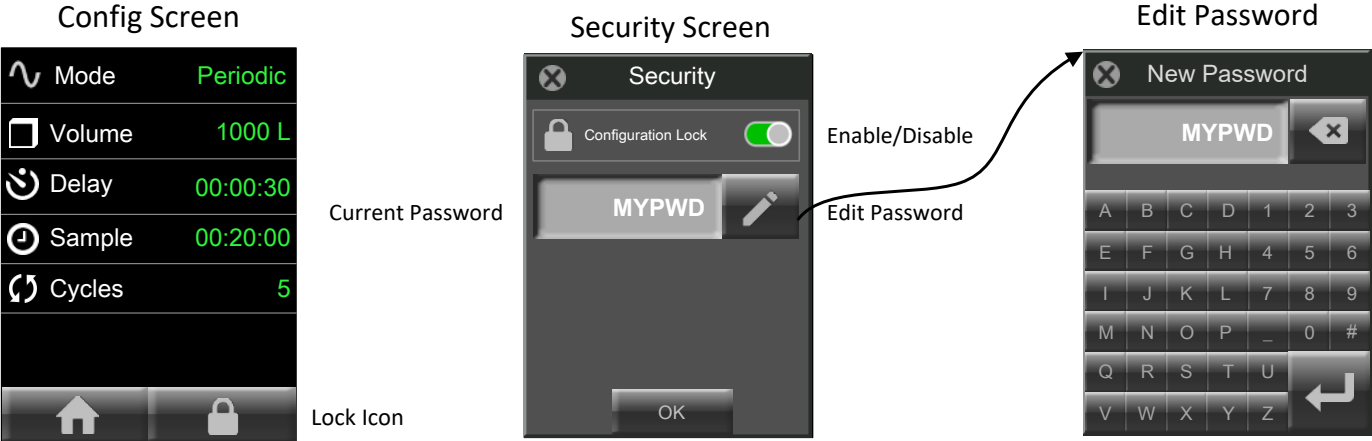

- Press the Edit Password button (pencil icon) to bring up the New Password screen
- Enter the new password and press the return key to save and return to the Security screen.
- Slide the Configuration Lock toggle button to the right for ON or to the left for OFF.
- Press OK to save the Security Settings.

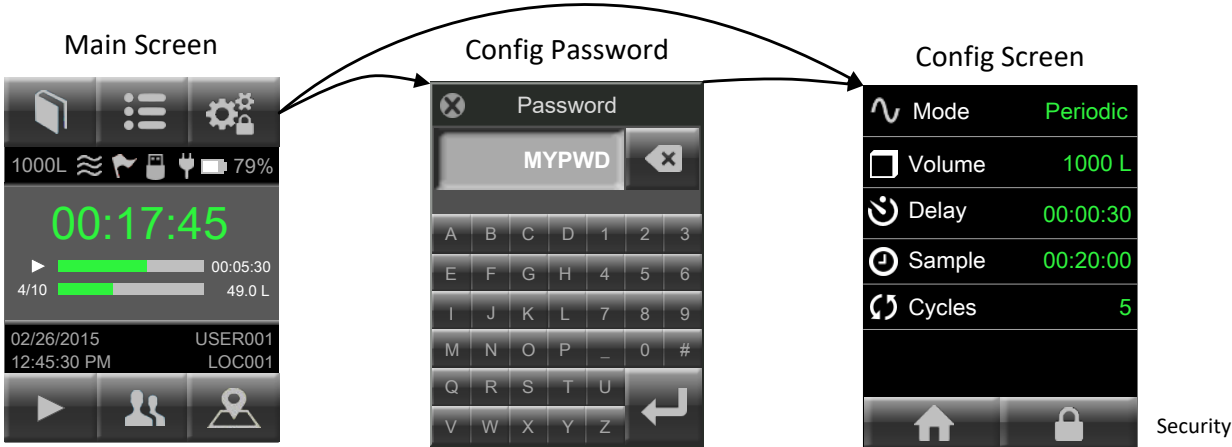

## Status LED Indicates Sampling Status

**Status LED color and blink rate:** The following table describes ActiveCount100 LED status.

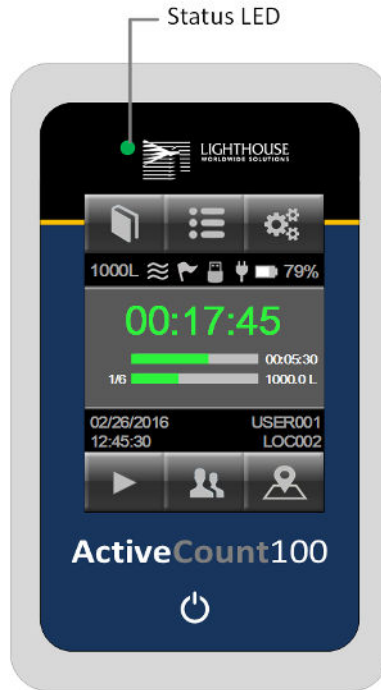

Status	Color	Blink
Idle	Off	Off
Sampling	Blue	Solid
Delay/Pause	Green	Solid
Flow Error	Red	Blinking
Writing to USB	White	Solid
Service/Calibration Required	Yellow	Solid



**White LED Indicates Writing To USB Flash Drive:** Do not remove USB flash drive and do not power off ActiveCount100 while LED is white and downloads are in progress.

## Sampling Status Screens

**Display Sampling Status Screens:** When a sampling run completes, ActiveCount100 displays a dialog box to indicate (a) success, (b) manual abort by user, or (c) flow error.



(a) Success                      (b) Manual abort by user                      (c) Flow error

## Sampling Run Metadata

**Display Sampling Results:** To display metadata results for the most recent sampling run, press METADATA button.

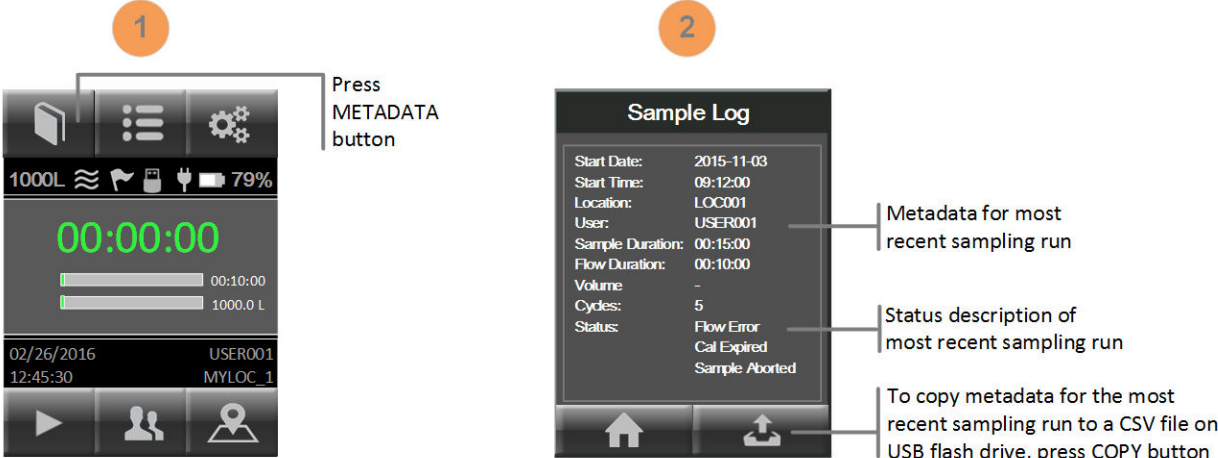

**Copy Metadata to USB Flash Drive:** To append metadata for the current sampling run to a CSV (Comma Separated Value) file, press COPY button. For more information on ActiveCount100 CSV files, see Appendix A, *Data Files*.

# Total Sampling Volume

## Select Total Sampling Volume

---

**Constant and Periodic sampling volumes:** ActiveCount100 supports up to eight programmable sampling volumes.

- 20 liters
- 50 liters
- 100 liters
- 200 liters
- 300 liters
- 500 liters
- 700 liters
- 1000 liters (default)

**Select Active Sampling Volume:** When you press on the Volume menu item, ActiveCount100 displays eight sampling volumes. ActiveCount100 indicates the active sampling volume with a dashed line.

## Active Volume Applies to Sampling Runs

---

**ActiveCount100 uses active sampling volume for subsequent sampling runs:** To select a new active sampling volume, press the desired volume button.

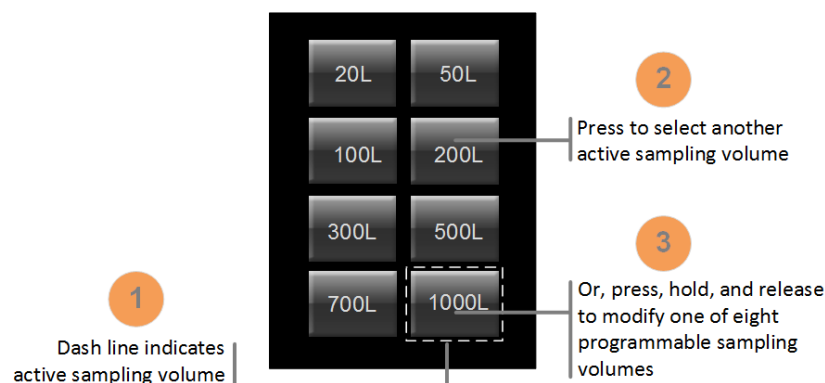

**Modify Sampling Volume Preset Values:** To modify a sampling volume value, press and hold then release a sampling volume button. ActiveCount100 then displays a keypad to enter a new sampling volume value. The new value then becomes the active sampling volume.

# Locations and Users

## Assigns Active Location to Sampling Runs

**Locations Database:** ActiveCount100 stores up to 400 locations in its Locations database. When ActiveCount100 completes a sampling run, it saves the active location in a metadata record for the most recent sampling run. Each location can consist of up to 16 characters.

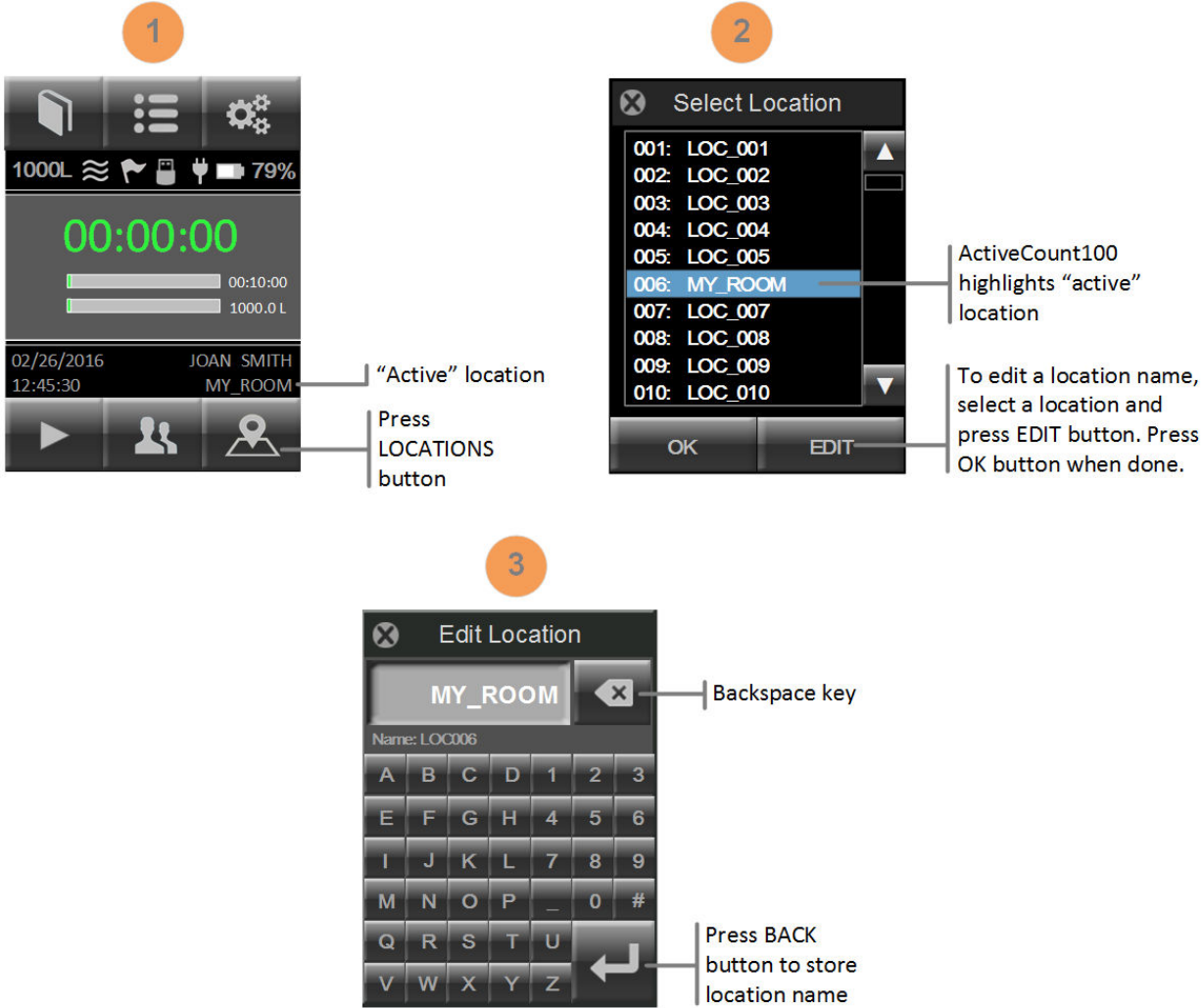

## Assigns Active User to Sampling Runs

**Users Database:** ActiveCount100 stores up to 50 users. When ActiveCount100 completes a sampling run, it saves the active user in a metadata record for the most recent sampling run. Each user name can consist of up to 16 characters.

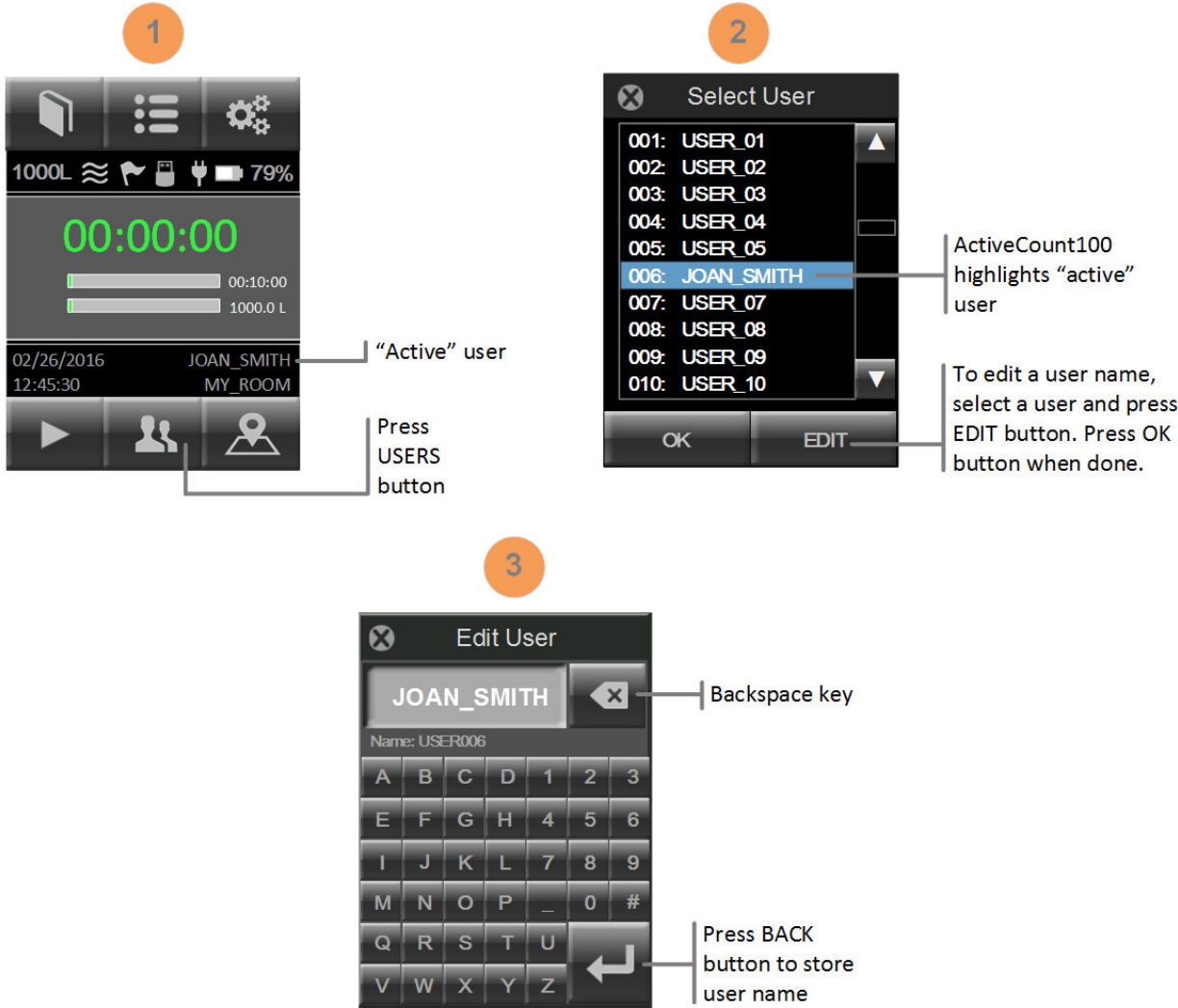

# Data Logging – Sampling Metadata

## Save Sampling Metadata to USB Flash Drive

**No USB Flash Drive:** If no USB flash drive is plugged into the rear USB port, ActiveCount100 stores metadata only for the most recent run in volatile memory, which ActiveCount100 deletes when ActiveCount100 is turned off. For information on displaying metadata for the most recent sampling run, see Section *Display Sampling Metadata*.

**USB Flash Drive:** When a USB flash drive is plugged into the rear USB port, ActiveCount100 displays a USB flash drive icon on the HOME screen.

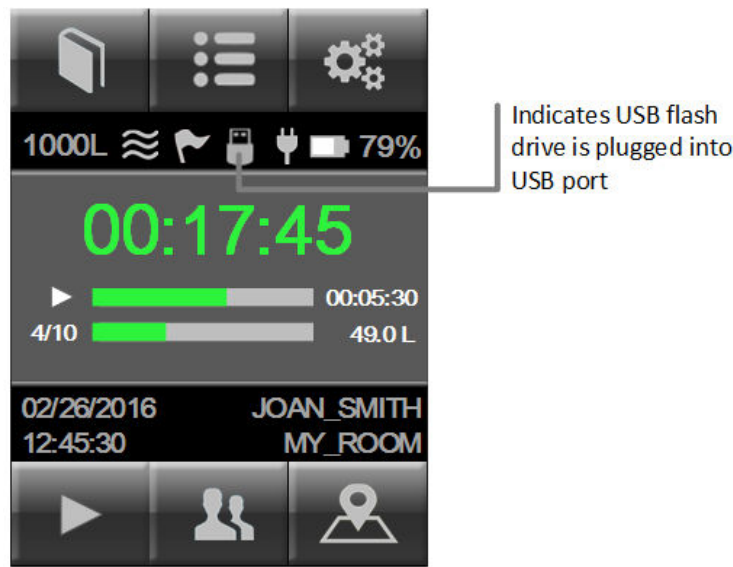

**Save Sampling Metadata to USB Flash Drive:** ActiveCount100 appends one line of metadata for each sampling run to a comma-separated value (CSV) file on the USB flash drive.

Export sampling metadata stored on the USB flash drive to third-party software, such as laboratory information management (LIM) systems.

For information on ActiveCount100 CSV files, see Appendix A, *Data Files*.

# Status Indicators

## Device Status Indicators

**Status Indicators:** ActiveCount100 displays status indicators on the Home screen. If ActiveCount100 displays Device status flag, it may indicate a device issue or problem. To display more device status information, press SETTINGS button, then press the Status menu item.

**1** Press SETTINGS button

**Status indicators**  
 Target sampling volume  
 Good flow, Flow error  
 Device status flag  
 USB drive detected  
 Charge status  
 Battery level

**2** Press to display device status  
 If Home screen displays the Device status flag, possibly indicating a device issue, press Status in this screen to see status information.



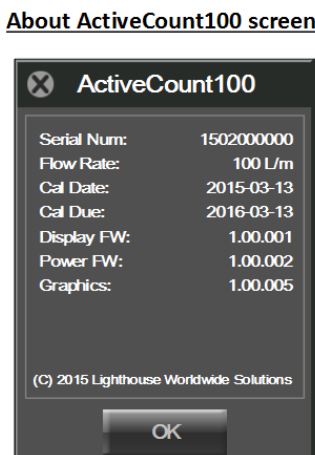
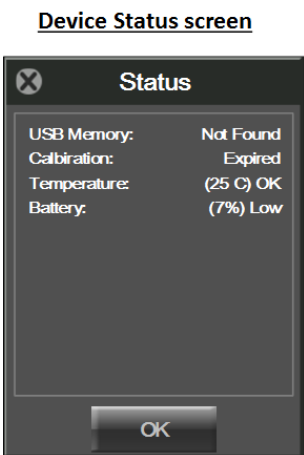

**About ActiveCount100**  
 Press to display information about this unit, including serial number, flow rate, calibration date, calibration due date, and firmware version numbers.

Sample status screens are shown below.





The following table describes status icons.

Icon	Status Indicator	Description
1000L	Target Sampling Volume	Target flow volume.
	Good flow or Flow error	Flow status while sampling.  If a flow error condition persists, contact Lighthouse Service and Support. See Section <i>Technical Specifications</i> for contact information.
	Device status flag	Possible device error, e.g., flow error, calibration due, etc. To display the device status, press SETTINGS button and Status menu item.  The sampling database stores these errors in CSV files. See subsection <i>Sampling databases</i> in Appendix A, <i>Database files</i> .  If this condition persists, contact Lighthouse Service and Support. See Section <i>Technical Specifications</i> for contact information.
	USB flash drive	USB flash drive inserted into rear USB port.
	Power adapter connected	Power adapter plugged in and charging battery.
	Battery	Current battery level.

# Settings

## ActiveCount100 Settings

---

**Device Settings:** Press SETTINGS button to display and edit device settings.

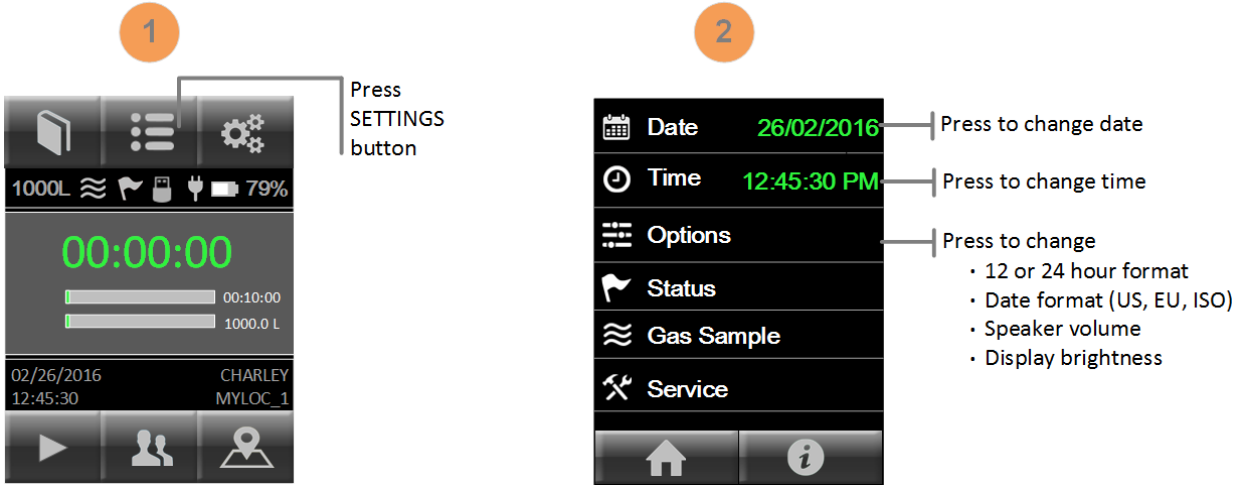

# Tripod/Monopod

## Vertical and Horizontal Sampling

---

**Vertical Sampling:** Place ActiveCount100 on a horizontal surface to sample vertically.

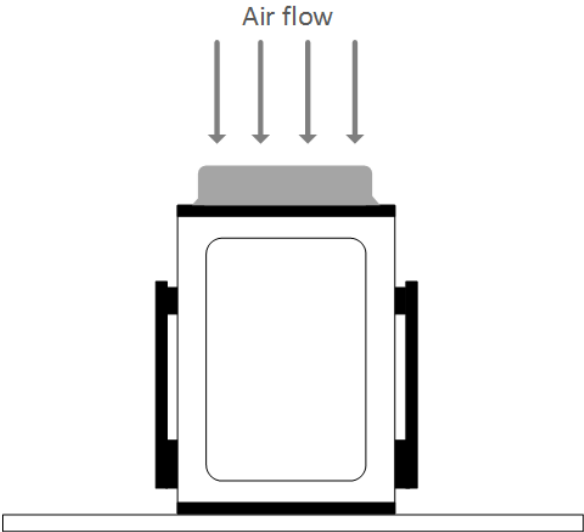

**Horizontal Sampling:** Mount ActiveCount100 on a tripod/monopod and turn the instrument to sample horizontally. ActiveCount100 supports 3/8" tripod/monopod screws and 1/4" tripod/monopod screws using the included adapter.

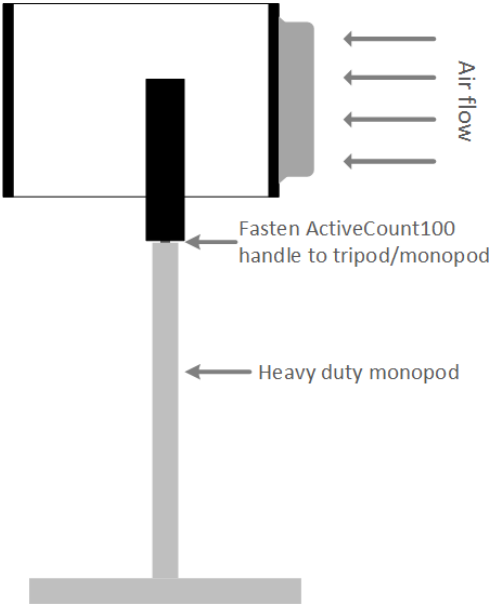

# Optional Compressed Gas Sampler

## Verify Nominal Flow Before Gas Sampling

Before using the optional compressed gas sampler, first verify nominal flow of ActiveCount100 without the gas sampler.

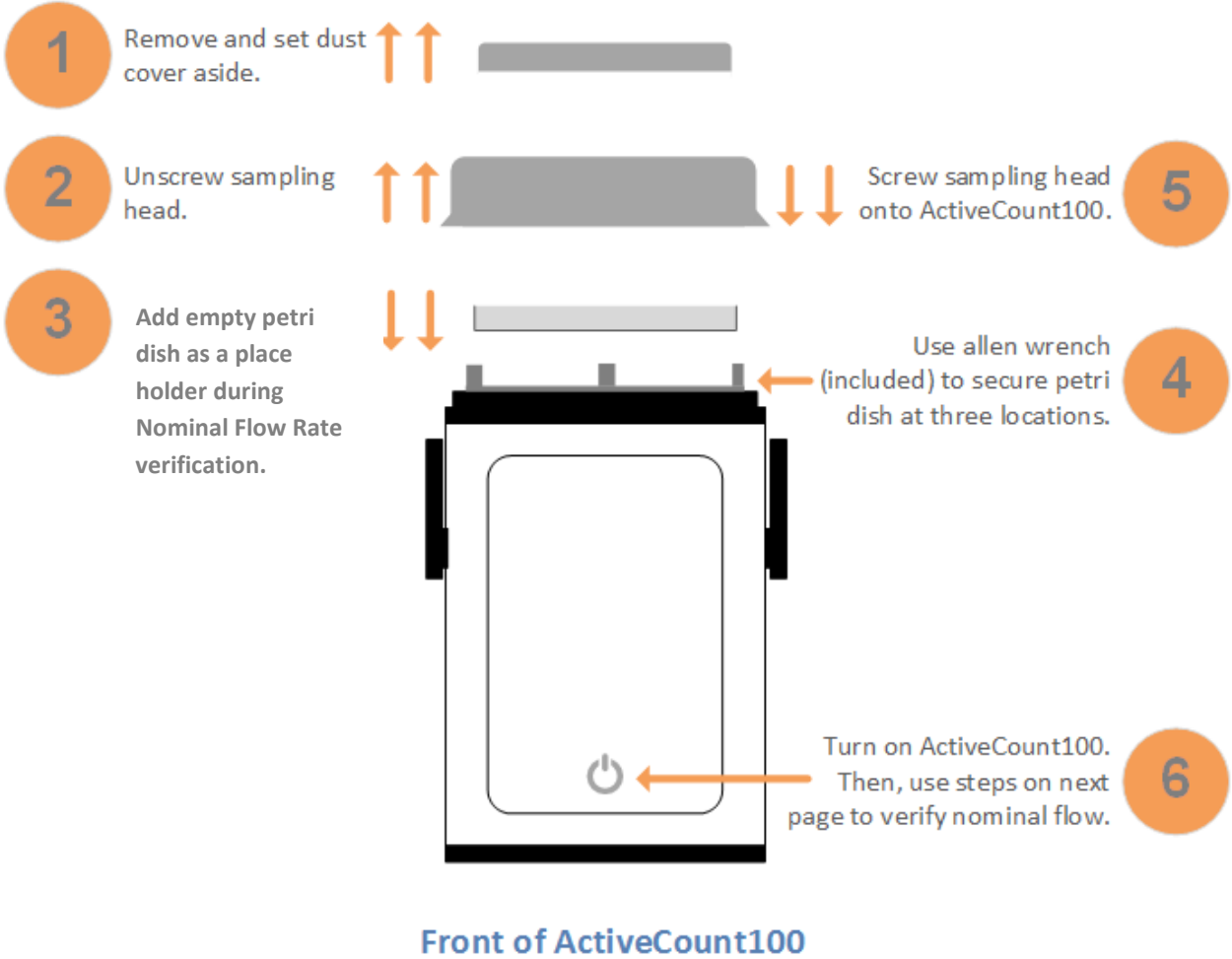

To verify ActiveCount100 nominal flow rate, follow the steps below.

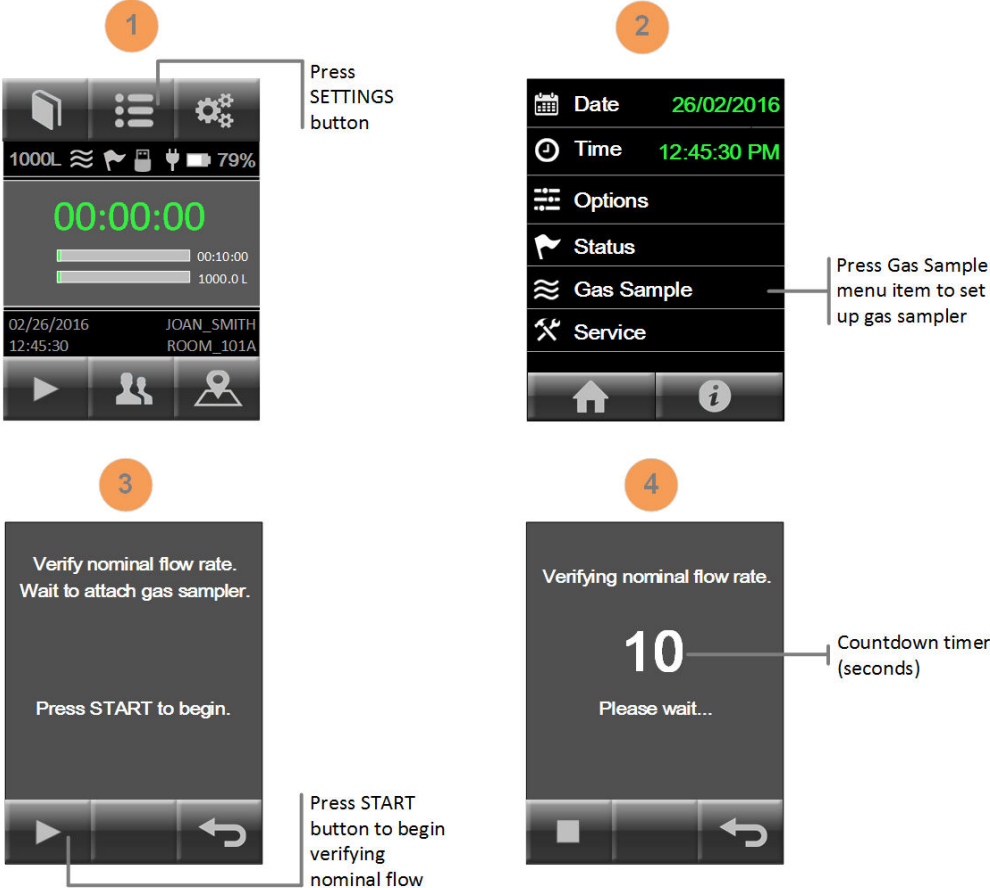

When ActiveCount100 displays the following screen, position gas sampler snugly in the sampling head while ActiveCount100 blower is running.

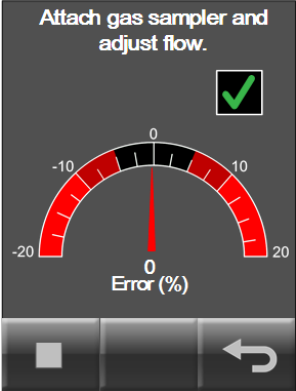

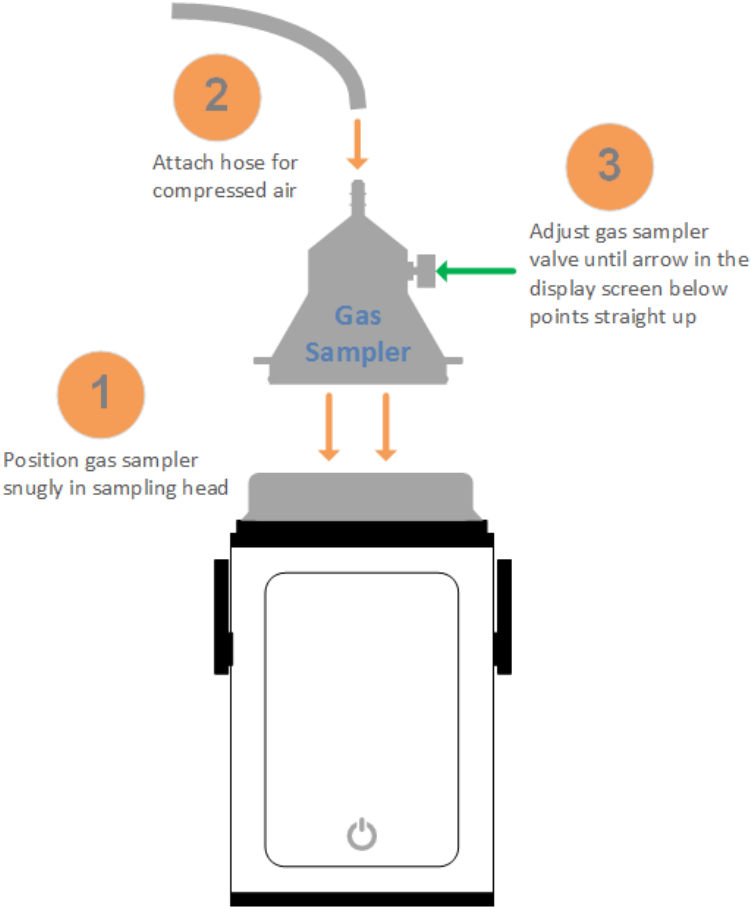

Adjust the gas sampler valve until the arrow in the display screen points straight up for nominal flow.

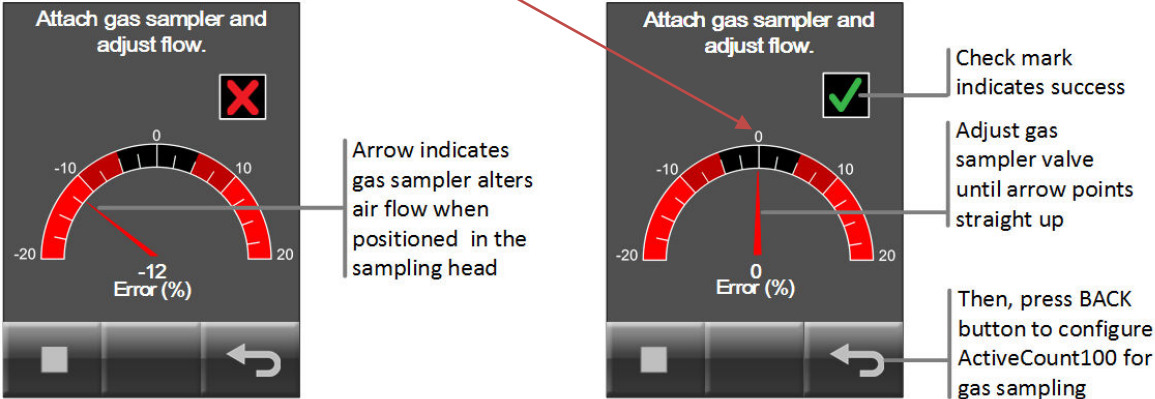

ActiveCount100 and the Gas Sampler adapter are now ready to sample compressed gas. Press the BACK button to configure your gas sample.



**Do not sample explosive nor corrosive gases.** ActiveCount100 gas sampler is designed to sample compressed air only, and is not designed for sampling of explosive nor corrosive gases.

# Clean and Disinfect

## Avoid Cross Contamination

---

Sterilize ActiveCount100 after each cycle to avoid cross-contamination, which can adversely affect reliability of microbial samples. Always wear a pair of sterile gloves when sterilizing ActiveCount100. Sanitize gloved hands first, with a disinfectant solution.

Use a commercial disinfectant solution, such as 70% - 90% ethanol solution or 60% - 80% isopropanol/water solution.

## External Enclosure

---

To clean the external surface, spray a commercial disinfectant solution or 60% - 80% isopropanol/water solution on a sterile tissue or wipe. Then, wipe the enclosure and petri dish holder with the damp tissue.

Wipe dry with another sterile tissue. Always full remove and wipe dry the disinfectant solution before reusing ActiveCount100. Let dry at room temperature.

## Sampling Head & Dust Cover

---

Remove sampling head and dust cover from ActiveCount100. Partially or fully blocked sampling head holes require an ultrasonic bath to remove the particles. Afterward, use an autoclave to sterilize the sampling head and dust cover; follow a standard sterilization procedure, e.g., 134°C at 18 minutes for hospital applications. Let dry at room temperature.

It is important to sterilize the sampling head and dust cover between samples. If an autoclave is not available, use a sterile cloth with disinfectant to wipe down the sampling head and dust cover. Let dry at room temperature.

## Transport

---

When transporting ActiveCount100, clean and disinfect as described in this Section. Then, transport ActiveCount100 in a sterile plastic bag.

## Warnings

---



- **To minimize the chance of electric shock, turn off and disconnect power adapter during sterilization.**
- **Do not submerge ActiveCount100 in any liquids.**
- **Do not spray disinfectant solution directly into ActiveCount100 enclosure.**
- **Do not use gases to disinfect ActiveCount100.**
- **Lighthouse will void the warranty if an unsuitable disinfectant solution damages ActiveCount100.**



# Calibration

## Calibration – Contact Authorized Facility

---

ActiveCount100 is factory calibrated to 100 liters/min  $\pm$  4%. Contact a factory authorized facility to calibrate ActiveCount100 annually.

To display calibration due date, see Section *Settings*.

# Technical Specifications

## Benefits

---

- Compact design
- User-friendly and easy to use
- Reliable measurements
- Low cost of ownership
- Includes calibration certificate

## Features

---

- Uses standard ISO 24998 90mm (85mm to 91mm) petri dishes
- Airflow 100 liters/min  $\pm$  4%
- Large 3.5-inch color touchscreen
- Eight programmable volumes
- 50 programmable users
- 400 programmable locations
- Programmable start delay
- Constant mode with programmable delay, sample duration, and volume
- Periodic mode with programmable cycles, delay, sample duration and volume
- Body made from stainless steel
- Sampling head made from anodized aluminum
- Optional sampling head made from polished stainless steel
- Autoclavable sampling heads
- Battery status indicator
- Internal rechargeable battery, approximately 6 hours typical usage
- Alarm on flow fault and low battery
- Status Indicators
- USB Port
- Speaker for alerts and notifications
- Download sampling metadata to USB flash drive
- Real time clock
- CE approval
- Operating conditions 0 to 35°C, humidity 0 to 80% RH
- Weight 2.4 kgs, 5.3 lbs
- Size 14.3 cm width, 14.3 cm depth, 19.8 cm height (excluding handle)
- Size 5.6" width, 5.6" depth, 7.8" height (excluding handle)
- Power 100-240 VAC, 50-60Hz external DC power adapter
- Limited 2 Year Warranty

## Package Contents

---

- ActiveCount100 with aluminum sampling head, dust cover
- USB flash drive
- 24V 3A DC power adapter
- Allen wrench to adjust petri dish holder
- Tripod/monopod adapter
- Calibration certificate
- Operating Manual (this document) supplied on USB flash drive
- Carrying case (carrying only, not shippable case)
- Optional stainless steel sampling head
- Optional gas sampler

## Conforming Specifications

---

- CE
- ISO 14698-1, Biocontamination Control, Cleanrooms, Associated Control Environments
- ISO 14698-2, Biocontamination Control, Cleanrooms, Associated Control Environments
- Good Automated Manufacturing Practice, GAMP, December 2001
- Good Manufacturing Practice, GMP, Volume 4, rules governing medicinal products

## Additional Help

---

For more information, contact Lighthouse Worldwide Solutions.

Service and Support

Tel: 1-800-945-5905 (Toll Free USA)

Tel: +1-541-770-5905 (Outside USA)

[techsupport@golighthouse.com](mailto:techsupport@golighthouse.com)

[www.golighthouse.com](http://www.golighthouse.com)



```

"J Smith"
"P Brown"
"Alice Chow"
"Ray Lopez"
. . .

```

## Sampling Run Databases

---

**Sampling Metadata in CSV Files:** ActiveCount100 stores sampling metadata in the following files:

```
/Active Count 100_<serial-number>/acsamples_<date>.csv
```

Where <date> is today's date, e.g., YYYY-MM-DD. ActiveCount100 appends one line of sampling metadata for each sampling run.

Export sampling metadata to third-party software, such as Laboratory Information Management (LIM) systems, to complement data from other monitoring systems.

Each sampling database file contains the following comma-delimited fields for each sampling run.

	CSV Field	Description	Sample Value
1	Timestamp	Date format – set in Settings menu <ul style="list-style-type: none"> <li>US (MM/DD/YYYY)</li> <li>EU (DD/MM/YYYY)</li> <li>ISO (YYYY-MM-DD)</li> </ul> Time (local 24-hour time) <ul style="list-style-type: none"> <li>HH: MM</li> </ul>	7/16/2015 9:48
2	Location	Current location	LOC004
3	User	Current user	Ray Lopez
4	Sample Duration	Total duration of sampling run in minutes	0:10:00
5	Flow Duration	Actual sampling time in minutes	0:10:00
6	Volume	Liters of air sampled	1000
7	Cycles	Constant sampling = 1 Periodic sampling = number of user-specified cycles	1
8	Status	No errors detected = Success At least one error detected = Error	Success
9	Flow	Flow good = OK Flow error = Error	OK
10	Service Needed	No service needed = OK Service needed = Error	OK
11	Calibration	Calibration not yet due = OK Calibration due = Error	Error
12	Sample Aborted	User did not abort sampling run = OK	Error

	CSV Field	Description	Sample Value
		User aborted run (no sample) = Error	
13	Temperature	Temperature normal = OK Temperature too high = Error	OK
14	Battery	Battery normal = OK Battery low (sample stopped) = Error	OK
15	USB Memory	USB flash drive detected = OK USB flash drive not detected = Error	Error
16	Model Name	ActiveCount100 model name	ActiveCount100
17	Serial Number	ActiveCount100 serial number	0123456789
18	Flow Rate	ActiveCount100 flow rate	100 L/m
19	Last Calibration	ActiveCount100 date last calibration	1/1/2016
20	Calibration Due	ActiveCount100 date for next calibration	1/1/2017
21	Firmware 1	ActiveCount100 display firmware version	0.01.004
22	Firmware 2	ActiveCount100 power firmware version	0.0.002
23	Firmware 3	ActiveCount100 graphics firmware version	1.0.006

# Appendix B: Feller Conversion Table

## Sampling Head with 300 Holes x 0.6mm

- R = number of Colony Forming Units (CFU) counted on 90 mm petri dish agar after incubation
- P<sub>R</sub> = Most Probable Number (MPN) of microorganisms in volume of air sampled
- N = number of holes in ActiveCount100 sampling head (300)

R	P <sub>R</sub>	R	P <sub>R</sub>	R	P <sub>R</sub>	R	P <sub>R</sub>	R	P <sub>R</sub>	R	P <sub>R</sub>
1	1	51	56	101	123	151	209	201	332	251	541
2	2	52	57	102	124	152	211	202	335	252	547
3	3	53	58	103	126	153	213	203	338	253	553
4	4	54	59	104	127	154	216	204	341	254	560
5	5	55	61	105	129	155	218	205	344	255	566
6	6	56	62	106	131	156	220	206	347	256	573
7	7	57	63	107	132	157	222	207	350	257	580
8	8	58	64	108	134	158	224	208	353	258	587
9	9	59	66	109	135	159	226	209	357	259	594
10	10	60	67	110	137	160	228	210	360	260	601
11	11	61	68	111	138	161	230	211	363	261	609
12	12	62	69	112	140	162	232	212	367	262	616
13	13	63	71	113	142	163	235	213	370	263	624
14	14	64	72	114	143	164	237	214	374	264	632
15	15	65	73	115	145	165	239	215	377	265	641
16	16	66	74	116	146	166	241	216	381	266	649
17	17	67	76	117	148	167	243	217	384	267	658
18	19	68	77	118	150	168	246	218	388	268	667
19	20	69	78	119	151	169	248	219	391	269	677
20	21	70	80	120	153	170	250	220	395	270	686
21	22	71	81	121	155	171	253	221	399	271	696
22	23	72	82	122	156	172	255	222	403	272	707
23	24	73	83	123	158	173	257	223	407	273	717
24	25	74	85	124	160	174	260	224	410	274	728
25	26	75	86	125	161	175	262	225	414	275	740
26	27	76	87	126	163	176	264	226	418	276	752
27	28	77	89	127	165	177	267	227	422	277	765
28	29	78	90	128	167	178	269	228	427	278	778
29	30	79	92	129	168	179	272	229	431	279	791
30	32	80	93	130	170	180	274	230	435	280	805
31	33	81	94	131	172	181	277	231	439	281	820
32	34	82	96	132	174	182	279	232	444	282	836
33	35	83	97	133	175	183	282	233	448	283	853
34	36	84	98	134	177	184	284	234	452	284	871
35	37	85	100	135	179	185	287	235	457	285	889
36	38	86	101	136	181	186	289	236	462	286	909
37	39	87	103	137	183	187	292	237	466	287	931
38	41	88	104	138	184	188	295	238	471	288	954
39	42	89	105	139	186	189	297	239	476	289	979
40	43	90	107	140	188	190	300	240	481	290	1006
41	44	91	108	141	190	191	303	241	486	291	1036
42	45	92	110	142	192	192	306	242	491	292	1069
43	46	93	111	143	194	193	308	243	496	293	1107
44	47	94	113	144	196	194	311	244	501	294	1150
45	49	95	114	145	198	195	314	245	507	295	1200
46	50	96	115	146	200	196	317	246	512	296	1260
47	51	97	117	147	202	197	320	247	518	297	1335
48	52	98	118	148	203	198	323	248	523	298	1435
49	53	99	120	149	205	199	326	249	529	299	1585
50	55	100	121	150	207	200	329	250	535	300	1885

NOTE: Table values calculated from  $P_R = N [1/N + 1/(N-1) + 1/(N-2) + 1/(N-R+1)]$  (Feller, 1950)

# Appendix C: Limited Warranty

## Limitation of Warranties

---

- A. Lighthouse Worldwide Solutions (LWS) warrants that all equipment shall be free from defects in material and workmanship under normal use for a period of two years from date of shipment to Buyer. LWS does not warrant that operation of the software will be completely uninterrupted or error free or that all program errors will be corrected. Buyer shall be responsible for determining that the equipment is suitable for Buyer's use and that such use complies with any applicable local, state, or federal law. Provided that Buyer notifies LWS in writing of any claimed defect in the equipment immediately upon discovery and any such equipment is returned to the original shipping point, transportation charges prepaid, within two years from date of shipment to Buyer and upon examination LWS determines to its satisfaction that such equipment is defective in material or workmanship, i.e. contains a defect arising out of the manufacture of the equipment and not a defect caused by other circumstances, including, but not limited to accident, misuse, unforeseeable use, neglect, alteration, improper installation, improper adjustment, improper repair, or improper testing, LWS shall, at its option, repair or replace the equipment, shipment to Buyer prepaid. LWS shall have reasonable time to make such repairs or to replace such equipment. Any repair or replacement of equipment shall not extend the period of warranty. If the Instrument is modified or in any way altered without the explicit written consent of LWS then the warranty is null and void. This warranty is limited to a period of two years, except as noted below, without regard to whether any claimed defects were discoverable or latent on the date of shipment. The length of warranty for pumps in hand held particle counters is one (1) year. Batteries and accessories with all products are warranted for one (1) year. Fuses and purge filters carry no warranty. If a third party battery is used in the product, the product warranty is null and void. If the battery is charged by a third party battery charger the battery warranty is null and void.
- B. If Buyer shall fail to pay when due any portion of the purchase price or any other payment required from Buyer to LWS under this contract or otherwise, all warranties and remedies granted under this Section may, at LWS's option, be terminated.
- C. THE FOREGOING WARRANTY IS EXCLUSIVE AND IN LIEU OF ALL OTHER REPRESENTATIONS, WARRANTIES AND COVENANTS, EXPRESS OR IMPLIED WITHRESPECT TO THE EQUIPMENT AND ANY DEFECTS THEREIN OF ANY NATURE WHATSOEVER, INCLUDING AND WITHOUT LIMITATION WARRANTIES OF MERCHANTABILITY OR FITNESS FOR A PARTICULAR PURPOSE. LWS SHALL NOT BE LIABLE FOR, AND BUYER ASSUMES ALL RISK OF, ANY ADVICE OR FAILURE TO PROVIDE ADVICE BY LWS TO BUYER REGARDING THE EQUIPMENT OR BUYERS USE OF THE SAME. UNDER NO CIRCUMSTANCES SHALL LWS BE LIABLE TO BUYER UNDER ANY TORT, NEGLIGENCE, STRICT LIABILITY, OR PRODUCT LIABILITY CLAIM AND BUYER AGREES TO WAIVE SUCH CLAIMS. LWS'S SOLE AND EXCLUSIVE LIABILITY AND BUYERS SOLE AND EXCLUSIVE REMEDY, FOR ANY NONCONFORMITY OR DEFECT IN THE PRODUCTS OR ANYTHING DONE IN CONNECTION WITH THIS CONTRACT, IN TORT, (INCLUDING NEGLIGENCE), CONTRACT, OR OTHERWISE, SHALL BE AS SET FORTH IN THE SUBSECTION A HEREOF AS LIMITED BY SUBSECTION B HEREOF. THIS EXCLUSIVE REMEDY SHALL NOT HAVE FAILED OF ITS ESSENTIAL PURPOSE (AS THAT TERM IS USED IN THE UNIFORM COMMERCIAL CODE) PROVIDED THAT THE SELLER REMAINS WILLING TO REPAIR OR REPLACE DEFECTIVE EQUIPMENT (AS DEFINED IN SUBSECTION A) WITH A COMMERCIALY REASONABLE TIME AFTER RECEIVING SUCH EQUIPMENT. BUYER SPECIFICALLY ACKNOWLEDGES THAT SELLER'S PRICE FOR THE EQUIPMENT IS BASED UPON THE LIMITATIONS OF LWS'S LIABILITY AS SET FORTH IN THIS CONTRACT.

## Warranty of Repairs After Initial Two (2) Year Warranty

---

- A. Upon expiration of the initial two-year warranty, all parts and repairs completed by an authorized Lighthouse repair technician are subject to a six (6) month warranty.
- B. Other than the above, LWS makes no warranty of any kind expressed or implied, except that the products manufactured and sold by LWS shall be free from defects in materials and workmanship and shall conform to LWS's specifications; Buyer assumes all risk and liability resulting from use of the products whether used singly or in combination with other products. If instrument is modified or in any way altered without the explicit written consent of LWS, then the warranty is null and void.
- C. WARRANTY REPAIRS SHALL BE COMPLETED AT THE FACTORY, BY AN AUTHORIZED SERVICE LOCATION, BY AN AUTHORIZED SERVICE TECHNICIAN, OR ON SITE AT BUYER'S FACILITY BY A LIGHTHOUSE AUTHORIZED EMPLOYEE. BUYER PAYS FREIGHT TO FACTORY; SELLER WILL PAY STANDARD RETURN FREIGHT DURING THE WARRANTY PERIOD. BUYER MAY SELECT A FASTER METHOD OF SHIPMENT AT ITS OWN EXPENSE.



**This Page Intentionally Left Blank.**

Service and Support  
Tel. 1-800-945-5905 (USA Toll Free)  
Tel. 1-541-770-5905 (Outside of USA)  
[techsupport@golighthouse.com](mailto:techsupport@golighthouse.com)  
[www.golighthouse.com](http://www.golighthouse.com)